

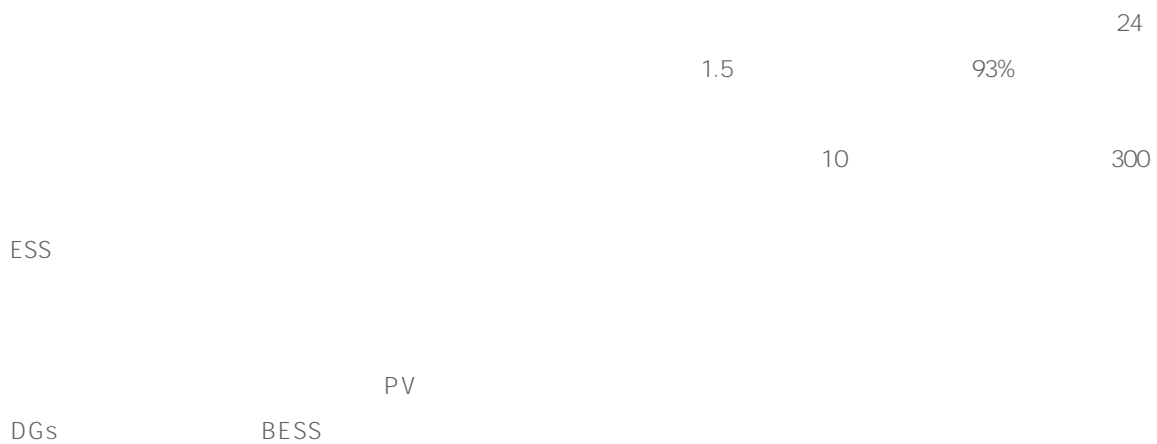

中东250kW/645kWh 锂电池储能项目

Case Study

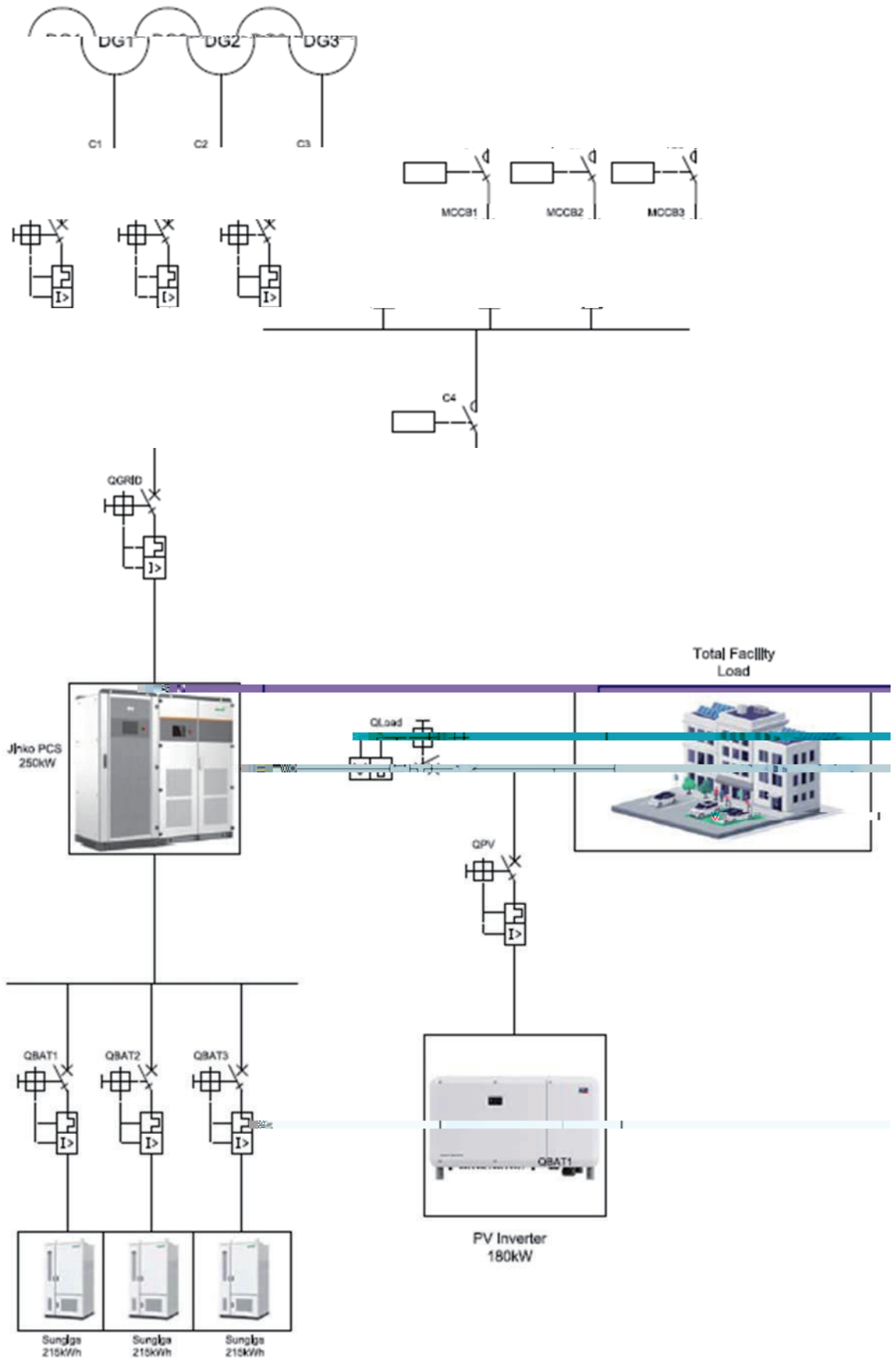



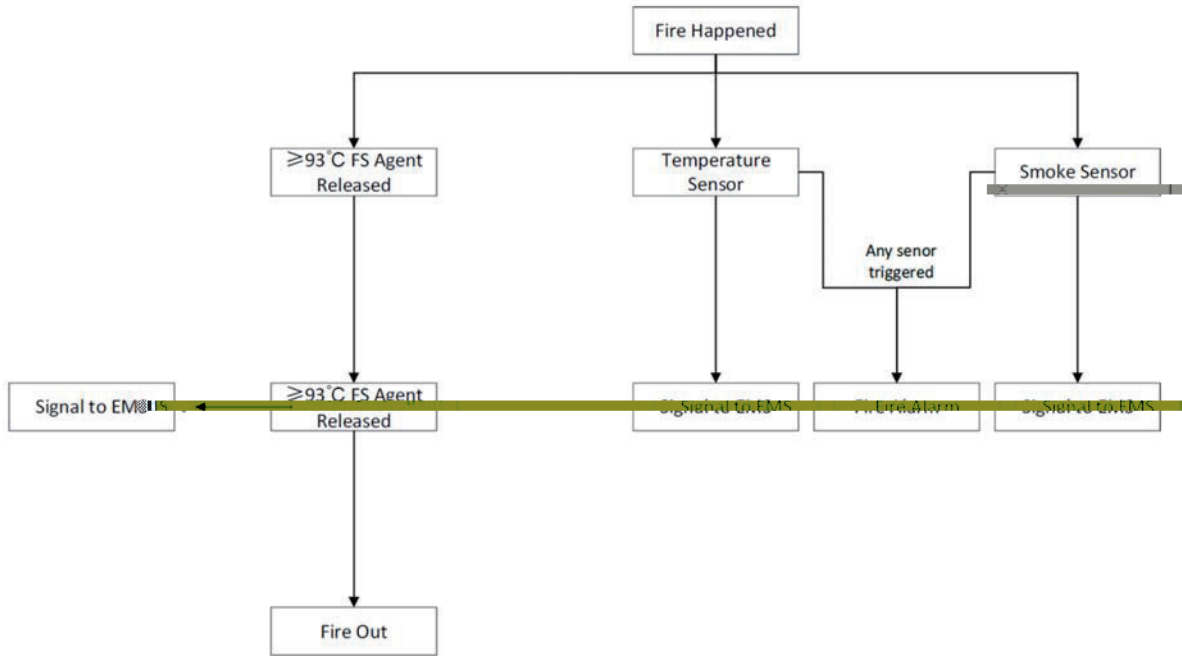

3

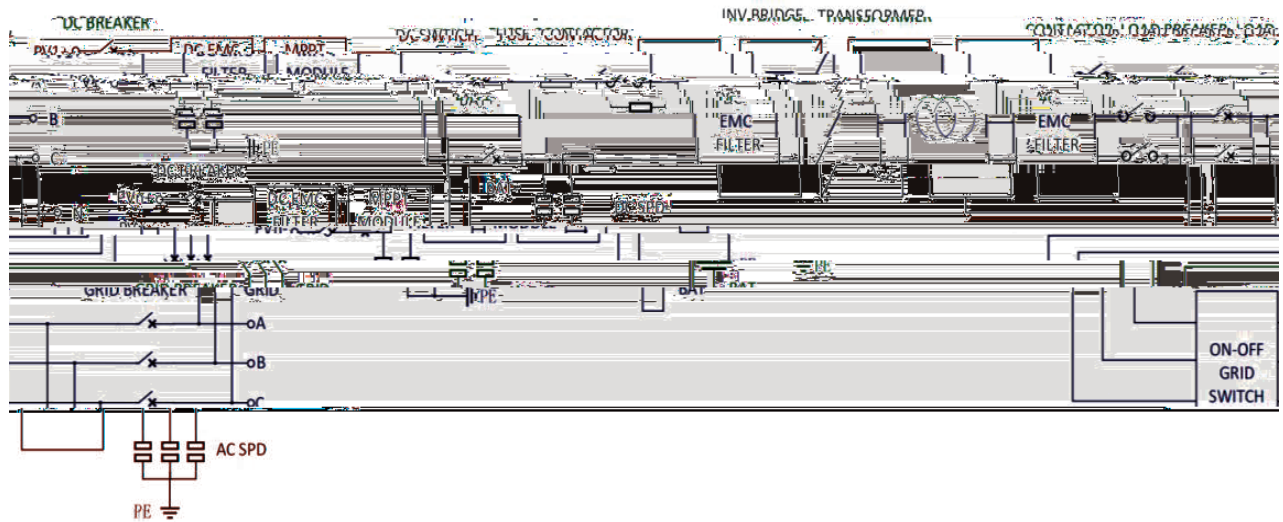

4 PCS

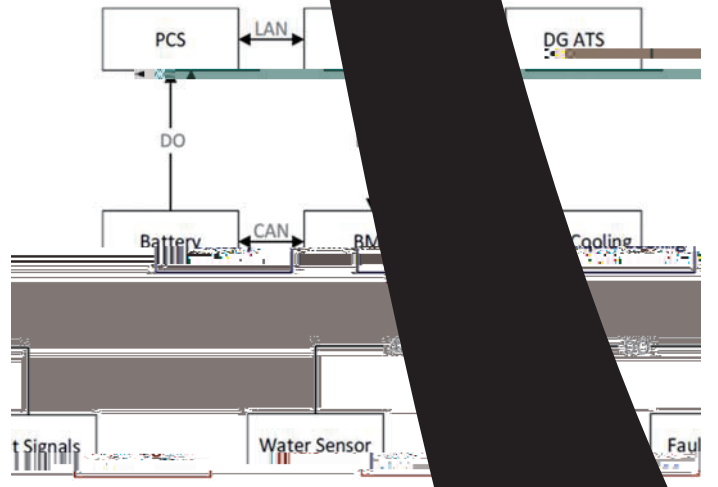

5 EMS

SCU

SCU

3

FSS

BMUs

BCUs

T

6

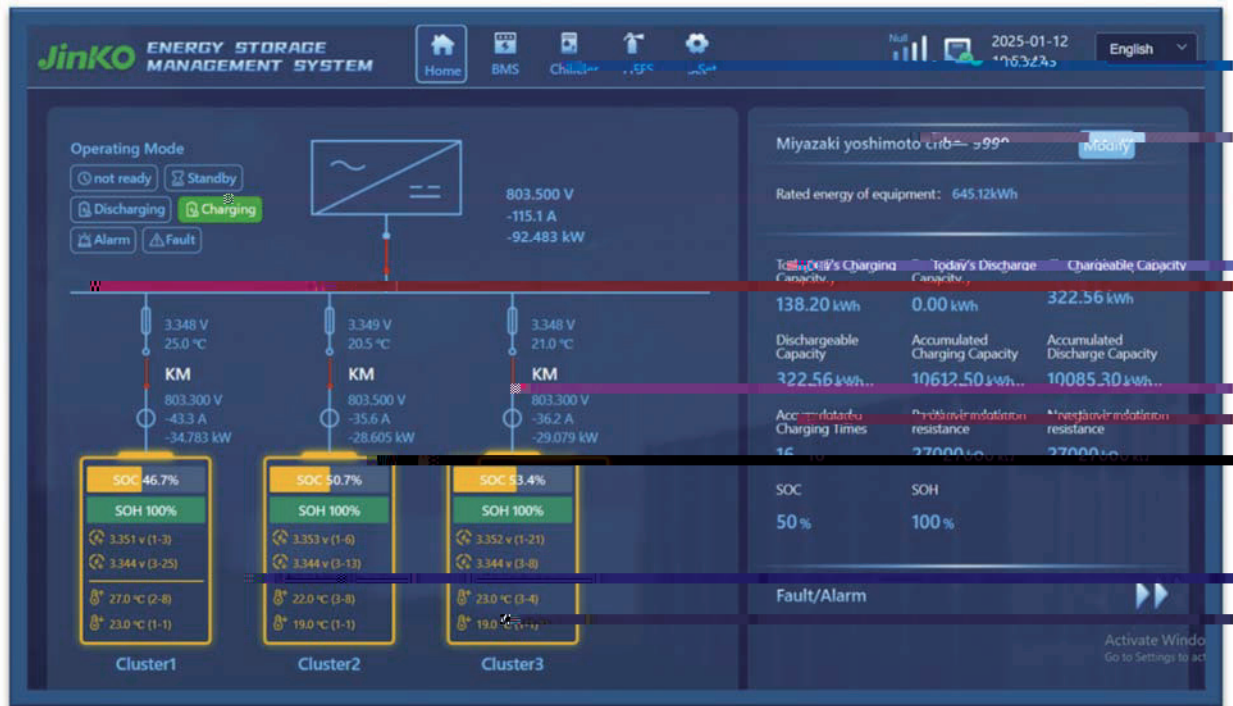

6 SCU



7

IoT

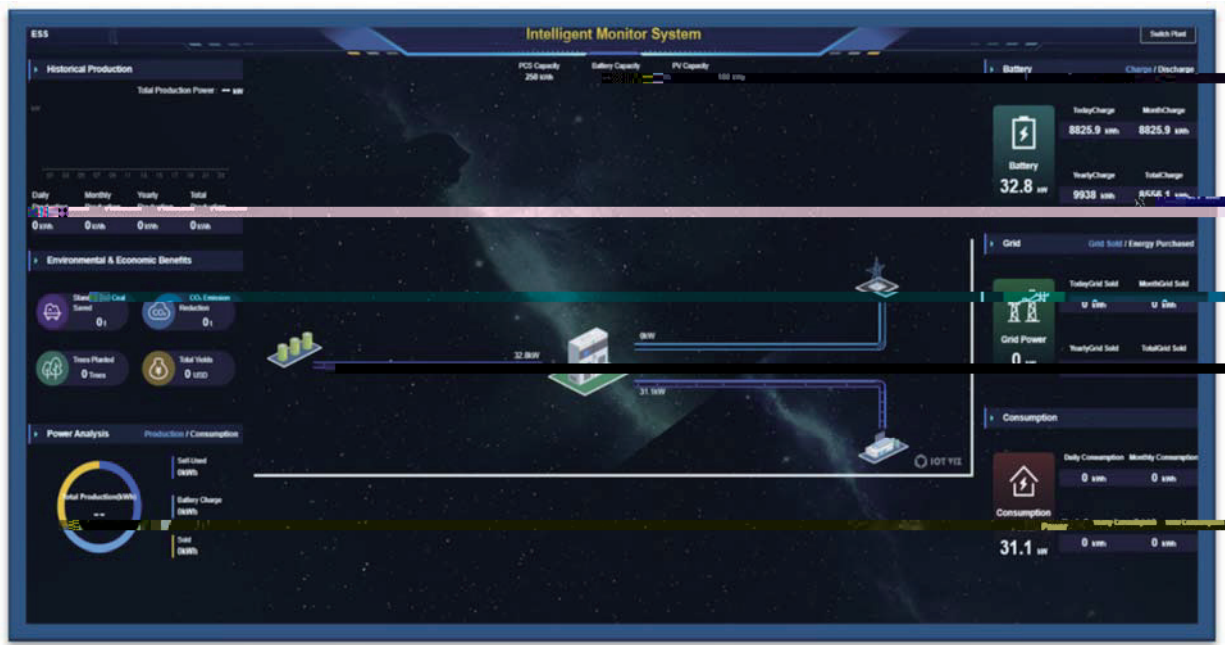

8 EMS

20% SOC 90
 SOC
 90% 100%
 9

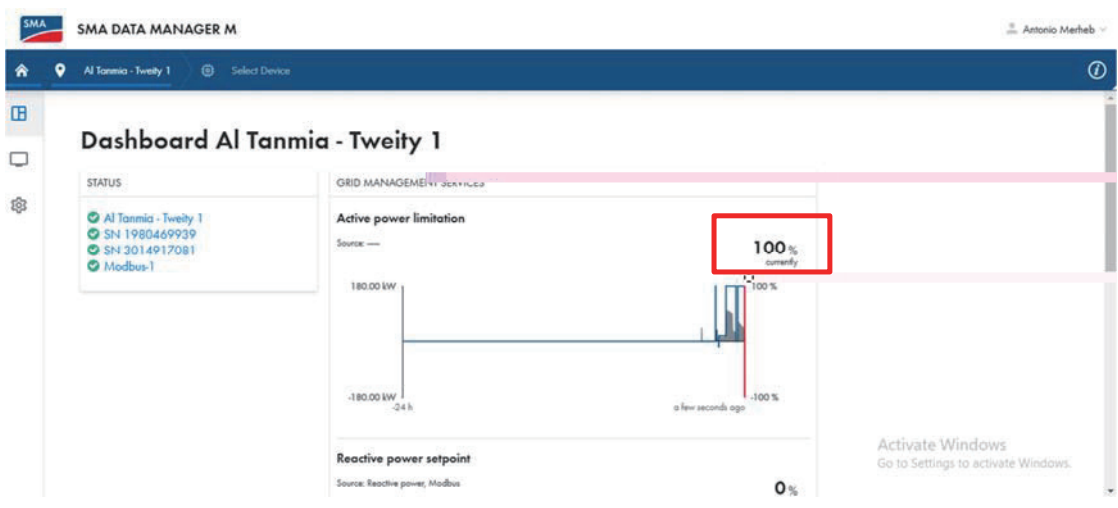

9 SMA EMS 100%





ESS
linkO

